

*Be Organised.
Be Admired.*



solo[®]
MANAGE YOUR SUCCESS



www.solo.in

Product Catalogue

SOLO Setting a new trend

It gives me great pleasure to take this opportunity to address you. These are exciting and challenging times at SOLO. India is poised to take on the world and Indian products will soon be at the forefront with the 'Make in India' movement; and SOLO is doing its part of making this happen.

Since its inception in 1997, SOLO has consistently endeavored to design and develop quality stationery products which are eons ahead of the competition. We're proud to say that today, pan India, SOLO has emerged as the preferred choice of discerning customers from multinational corporate organisations to prestigious schools and leading universities of India, and in the process become a household name.

The reason is quite obvious; SOLO's world-class range of products with unmatched quality, cutting edge technology, contemporary elegance and long lasting convenience. SOLO's impeccable range has gone beyond just files and folders. With a host of new-age, innovative and modern products that range from office accessories like paper and file trays to book & magazine racks and files; to CD covers, pen holders and desktop organizers. Add to this our interesting array of digital technology products like the Classroom Talky (Mp3/Recording) etc., we have a winning proposition ahead.

SOLO's history as an organization is full of new developments and firsts. Our launch of wide range of mechanical pencils & leads, available at all price points has helped us capture the market and highlighters from SOLO have been appreciated by one and all.

Our belief: "Quality has the same language nationally and internationally", shall continue to direct our efforts as we launch our world class range of white board & permanent markers. As always, you can expect innovative products like the 'clip-files' & folders which will be launched soon.

We stand resolute in our commitment, honesty & service to our consumers.

I would also like to this opportunity to express my gratitude to our numerous customers, retailers and distributors for making SOLO a market leader. Your continued trust and support means a lot to us. To meet the challenges ahead and fulfill all our stakeholders' expectations, we have re-imagined our company's strategic initiatives embracing sustainable business practices, focusing on enhancing customer experience, operational efficiency and people development. We're continuing to grow the business organically as well as inorganically.

The needs of society and our clients are transforming faster than we think. And we believe that if we don't move swiftly and respond accordingly, we won't be valued by society or our clients. So we are ever-transforming ourselves, taking on new challenges. We are proud of what we have achieved, but we recognise that the world in which we operate is constantly evolving and we need to adapt our thinking and behaviour accordingly, so that we stay ahead of the curve.

I would also like to thank our ever growing, all-India marketing network, because of whom SOLO product are now easily available across the length and breadth of the country, from metros to cities and towns; becoming a reputed brand to reckon against the available international brands.



Amit Gupta
Managing Director

FILEX SYSTEMS PVT. LTD.

Head Off.: 4546, i-2/16, 1st Floor, Ansari Road, Daryaganj, New Delhi-110002

+91-11- 23288150, 23288162 | support@filexindia.com | www.solo.in

Showroom: 2578, 1st Floor, Barsha Bulla Chowk, Nai Sarak, Delhi-110006

+91-11- 23255072 | showroom@filexindia.com



Ring Binders



Available in two clips

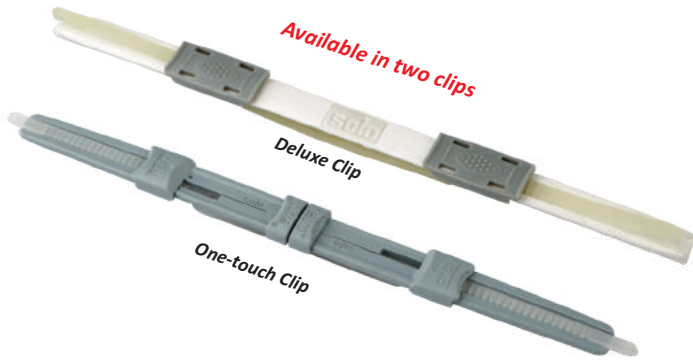

Deluxe Clip

One-touch Clip

Available in three variants

- | | | |
|---|---|---|
| RF 102
Top – Transparent
Back – Opaque | RF 101
Top & Back
Both Translucent | BF 101
Top & Back – Translucent
with inside Pocket |
|---|---|---|

Available in these colors

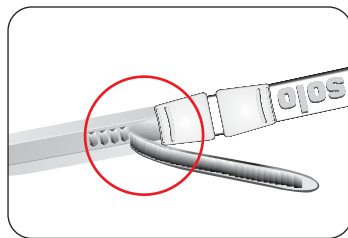
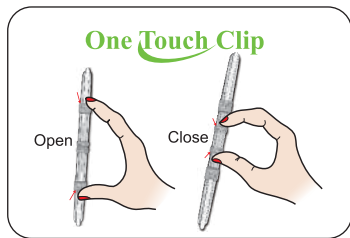
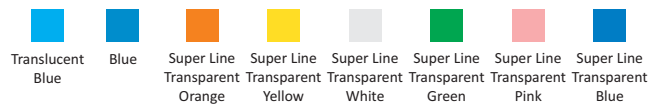

This Masterpiece in its class with high performance one touch clip for one hand operation along with superfine gripping mechanism that can hold paper firmly and also prevents tearing from punch holes. It is a perfect dress code for your reports and other precious documents. These are made with transparent tops & opaque covers considering the need of the consumers.

Code	Description	Size
RF 101	Report File	A4
RF 102	Report File (Transparent Top)	A4

Code	Description	Size
BF 101	Business File	A4
RF 111	Report File	F/C

Ring Binders

25mm RING-250 sheets

- Blue
- Red
- Green
- Grey
- Black



RING BINDER - RB 402 / A4, FC size
2-D-Ring with stopper.
Heavy duty polycover.
Pocket on inside cover for loose sheets.

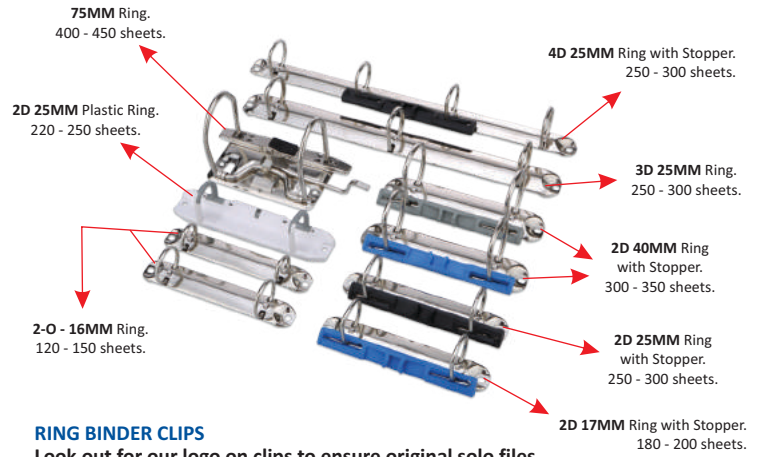

RING BINDER CLIPS

Look out for our logo on clips to ensure original solo files.

PREMIUM RING BINDER - RB 702 / A4 size

Stopper with the clip keeps documents firmly in place.
Pocket on inside cover for loose sheets.
Holds upto 240 sheets

- Blue
- Black
- Grey
- Neon Blue



Stopper Lock

DESIGNER'S RING BINDER - RB 434 / A3 size

4-D-Ring with stopper.
Extra thick sheet to carry bulk documents.



4D Ring With stopper

- Blue
- Black
- Grey

PAPER RING FILE - PRF03 | PRF04 - A4 size

High strength imported board.
Tough built stand firm in filing cabinets.

Paper Board



- Blue
- Red
- Green
- Grey
- Black

PAPER BOARD RING BINDER - RB 902 / A4 size

2-D-Ring with stopper. Printed Index table on inside cover. Imported light-weight strong paper board. Poly coated for durability.

Code	Description	Size
RB 401	Ring Binder-2-O-Ring (25mm Ring)	A4
RB 402	Ring Binder-2-D-Ring (25mm Ring)	A4
RB 403	Ring Binder-3-D-Ring (25mm Ring)	A4
RB 404	Ring Binder-4-D-Ring (25mm Ring)	A4
RB 405	Ring Binder-2-D-Ring (with front view Pocket, 25mm Ring)	A4
RB 406	Student's Ring Binder (17mm Ring)	A4
RB 407	Ring Binder-2-D-Ring (17mm, Economic)	A4
RB 408	Ring Binder-2-D-Ring	A5

Code	Description	Size
RB 702	Premium Ring Binder-2-D-Ring (25mm Ring)	A4
RB 411	Ring Binder-2-O-Ring (25mm Ring)	F/C
RB 412	Ring Binder-2-D-Ring (25mm Ring)	F/C
RB 434	Designer's Ring Binder-4-D-Ring (25mm Ring)	A3
MK 405	Ring Binder-2-D-Ring (40mm Ring, Rado Lock)	A4
MK 415	Ring Binder-2-D-Ring (40mm Ring, Rado Lock)	F/C
AR2A3	Designer's A3 Ring Portfolio (Handle & Zipper Closure)	A3
DURABLE PAPER BOARD RING BINDER		
RB 902	Paper Board-2-D-Ring (with Label Pocket, 25mm Ring, Rado Lock)	A4

Ring Binders

DESIGNER'S A3 RING PORTFOLIO AR2A3, A3 size

Zipper closure.
Extra thick sheet to carry bulk of documents.
Holds upto 160 sheets of 150 GSM paper.
Unmatched quality.

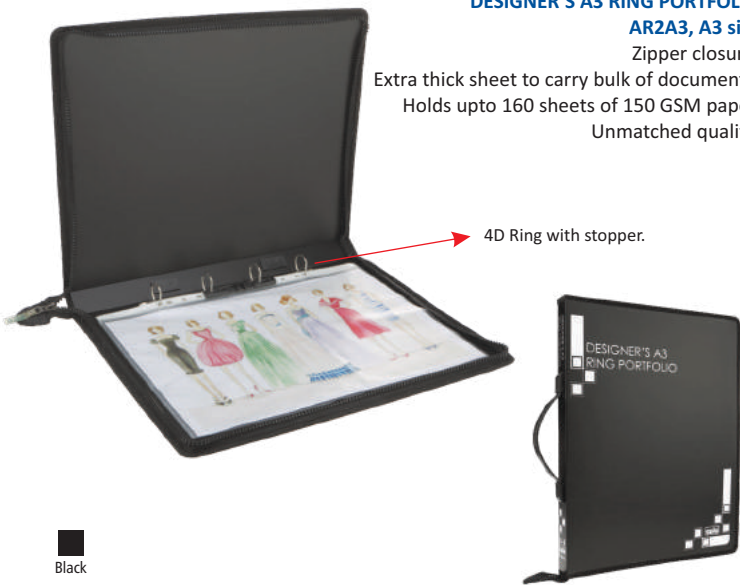

4D Ring with stopper.

Black

RING BINDER - 2D Ring, MK 405, MK415 / A4, FC size 40mm Ring, Rado Lock

Finger hole on spine to facilitate easy removal & stocking in shelves where files are contiguously stacked vertically.
Spine pocket to keep file index after nomenclature.

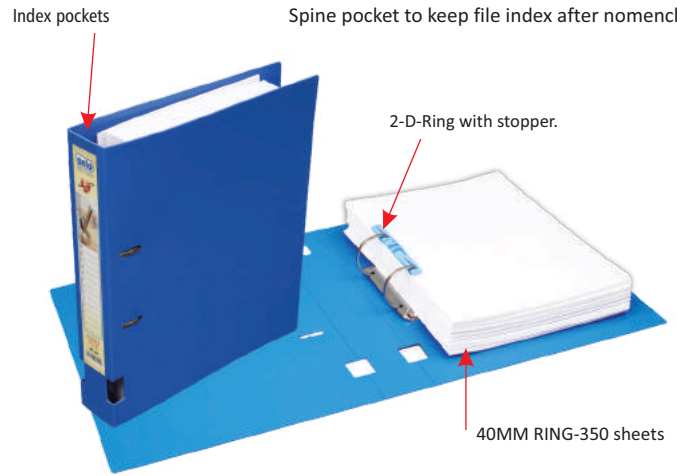

Index pockets

2-D-Ring with stopper.

40MM RING-350 sheets

Blue
Black
Grey

75 mm Capacity - 350 sheets

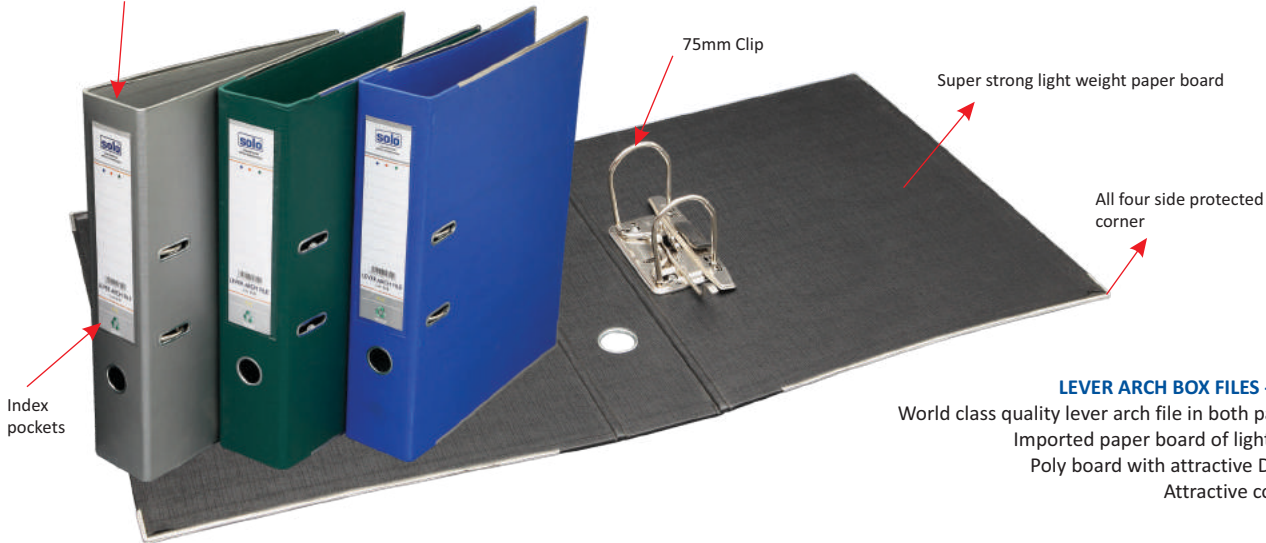

75mm Clip

Super strong light weight paper board

All four side protected corner

Index pockets

Blue
Red
Green
Grey
Black
Yellow
White

LEVER ARCH BOX FILES - LA502 / LA512 / A4, FC size

World class quality lever arch file in both paper board & polymer sheet.
Imported paper board of light weight yet double strength.
Poly board with attractive DNA wave texture on surface.
Attractive colors with life time durability.
Strong & tough built quality.

75 mm Capacity - 350 sheets

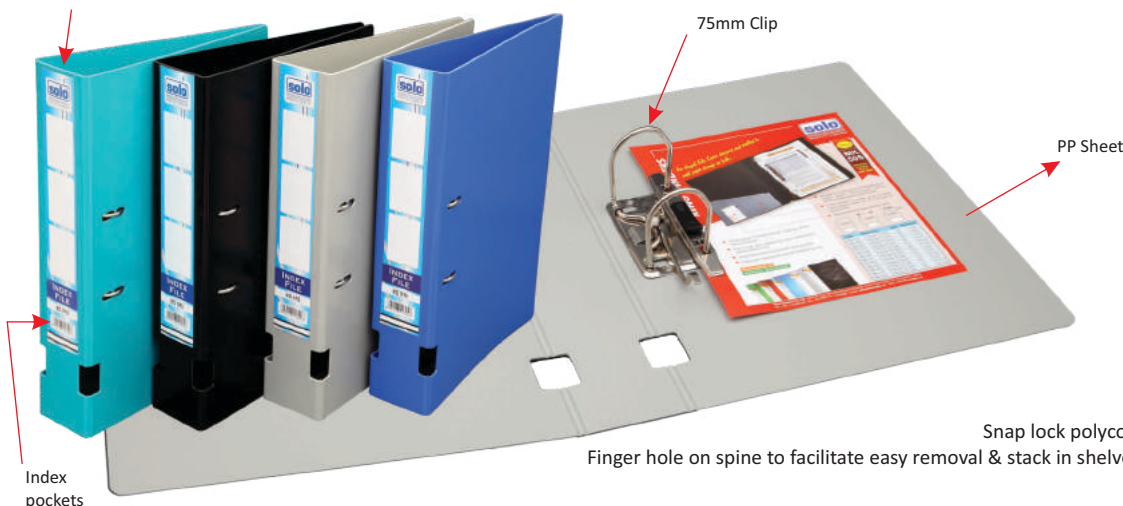

75mm Clip

PP Sheet

Index pockets



Blue
Black
Green
Grey

PP LEVER ARCH BOX FILES - XC515 / FC size

75mm chip mechanism with paper stopper.
Snap lock polycover helps file to stand firmly with documents.
Finger hole on spine to facilitate easy removal & stack in shelves where files are contiguously stack vertically.
Holds upto 400 sheets.
Spine pocket for holding index label.

Clip Files



■ Blue
■ Black
■ Grey
■ Tango Red
■ Tango Blue
■ Tango Yellow
■ Tango Green

PUNCHLESS FILE - PL 301 - A4, FC size
 PP cover with lever clip. Pocket on inside cover. Slot for business cards.

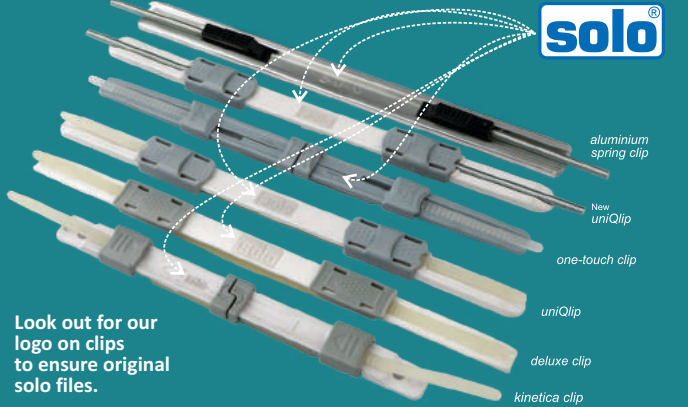

solo

aluminium spring clip
 New uniClip
 one-touch clip
 uniClip
 deluxe clip
 kinetica clip

Look out for our logo on clips to ensure original solo files.



■ Blue
■ Black
■ Grey
■ Tango Red
■ Tango Blue
■ Tango Yellow
■ Tango Green

SPRING ARCFILE - SG 503 - A4, FC size
 PP cover with exclusive aluminum channel-spring clip & wire prong duo. Pocket on inside cover. Slot for business cards.



■ Blue

Holds upto 350 sheets.

EXPANDO FILE - EF 101 - A4 size
 Space saver 'self expanding file' for modern offices. Transparent spine expands by itself as you add more papers. Multilayer flexi spine.



■ Blue
■ Black
■ Grey

UNIQLIP FILE - UF 101 - A4 size
 Smooth & rivet-less file cover. High performance uniClip™. One touch clip operation.

Transparent Visiting card & paper pockets



■ Blue
■ Black
■ Grey

SPRING & PUNCHLESS FILE - SG 502 - A4 size
 Twin clip file cover with strong polyboard. Additional lever clip on left to hold papers without punching. Holds upto 160 sheets.

Code	Description	Size
UF 101	UniClip File	A4
DC 101	Delux Clip File	A4
DC 111	Delux Clip File	F/C
PL 301	Punchless File (Lever Clip)	A4
PL 311	Punchless File (Lever Clip)	F/C

Code	Description	Size
SG 501	Spring Action File	A4
SG 502	Spring & Punchless File	A4
SG 503	Spring Arc File	A4
SG 513	Spring Arc File	FC
SG 603	New UniClip File	A4
EF 101	Expando File	A4

Clip Files



- Translucent Blue
- Translucent white

INSERT-X FILE™

IF201 / A4 size

- Full view of documents for delving through the contents.
- Large name card for classification.
- No sharp edges.
- Proper grade 'spring steel' wire used in fabrication.
- Rust-free spring & wire prongs for durability.
- Dimensionally matched components for firm grip to hold paper tightly.
- Zero hole, rivet-less construction.
- Proprietary fabrication process (patent applied).

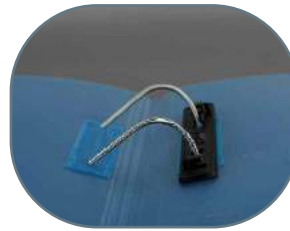

- Blue
- Black
- Grey
- Tango Red
- Tango Blue
- Tango Yellow
- Tango Green

Paper & visiting card pocket

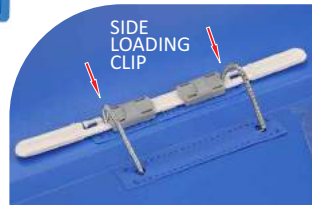

NEW UniQlip® FILE

SG603 / A4 size

- Patented design for easy handling and light weight.
- Rivet-less construction.
- Simple & swift.
- Good to file in upto 150 sheets.
- Dimensionally accurate components makes filing effortless.
- High quality steel finish with extra smooth edges.
- Full length springs reaching upto the base of prongs.
- No obstruction in paper path when shuffled.

ORDINARY FILE



TORN & WORN AT SPINE TOP & BOTTOM

TEAR-PROOF PLASTIC LAMINATED AT 'PICK & PLACE' SPINE TOP & BOTTOM



LamEdge™ PAPER BOARD FILES

KF101, KF102, KF111, KF112 / A4, FC size

The internationally acclaimed series of files from SOLO are named as 'Lam Edge'. As the name indicates that this attractive and long lasting range are laminated from top and bottom to prevent tearing while storing of files and are made from strong and long fibre paper board. Its strong construction gives long lasting assurance to the user and comes in three scintillating colors – Blue, Fawn and Orange. These are categorized in two different segments, Carat and Executive, considering the need of the user.

- Blue
- Orange
- Fawn

Available in two clip:
uniQlip
Delux clip

Report Covers/presentation Folders



**REPORT COVER (STRIP FILE)
RC 001 - A4 size**
Easy to attach strips. High resilience channel pinches 1 to 30 sheets firmly without losing strength.

Transparent Clear



REPORT COVER (SWING CLIP) - RC 601 - A4 size
Available in various colors with A4 size. Just swing out the clip, put papers and swing-in the clip back. Apt for displaying reports and projects. High resilience swing clip. Hold upto 50 sheets.

- Translucent Blue
- Magic Square Black
- Magic Super Grey
- Translucent White
- Green
- Red
- Metallic Blue
- Metallic Grey
- Translucent Green
- Super Line Transparent Orange

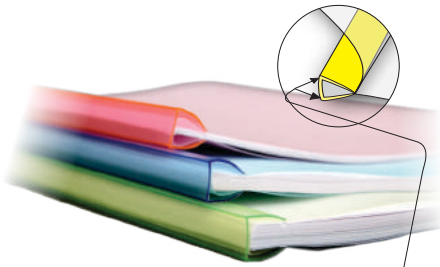

**REPORT COVER (STRIP FILE)
RC 002 - A4 size**
Extra wide transparent strips. Holds upto 60 sheets. Frosted poly covers.

Specially designed double creasing to prevent the strip slipping-off the file.

- Transparent Pink
- Transparent Green
- Transparent Blue



**REPORT COVER - RC 603
(Swing Clip) - A4 size**
Swing clip with transparent top & opaque back.

- Magic Square Blue
- Magic Square Grey

WINGER MECHNISM

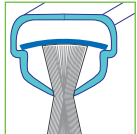

Transparent Clear

Extra Wide Strip to hold more papers



- Extra welded shoulder strip to give anti-slip function.
- Special Poly resins that gives extra clasping strength.
- Holds upto 50 sheets of paper firmly.

**GRIPTEC CHENNEL FILE- RC 003
(Swing Clip) - A4 size**
Very high clasping strength. Thick polycover. Multiple crease lines for convenient lay-flat opening of folder.



**PRESENTATION FOLDER - RC 607
(Twin pockets) - A4 size**
Two side pockets. Slots for business cards & CD case. Transparent/Opaque shades in several colors.

- Translucent Blue
- Smoke
- Metallic Grey
- Translucent White
- Translucent Green
- Blue
- Metallic Blue

Code	Description	Size
RC 001	Report Cover (Strip File)	A4
RC 002	Report Cover (Strip File - Wide & Thick)	A4
RC 003	Griptec Channel File	A4

Code	Description	Size
RC 601	Report Cover (Swing Clip)	A4
RC 603	Report Cover (Swing Clip/Transparent Top)	A4
RC 607	Presentation Folder	A4
RC 611	Report Cover (Swing Clip)	FC

Display Files

- Blue
- Black
- Grey
- Tango Red
- Tango Blue
- Tango Yellow
- Tango Green



DISPLAY FILE - DF 201, DF 211 - A4, FC size
20 Clear-view pockets. Non-stick, embossed polypropylene pockets. Extra large pockets to hold upto six sheets in each.

- Blue
- Grey



ZIPPER CLOSER - ZB 011, ZB 012 - FC size
20/40 Clear-view pockets. Zipper Closure. F/C size.



DISPLAY FILE - DF 302 - A4 size
20 Clear-view pockets. Side loading. Papers never fall-out of the file.

- Blue



CERTIFICATE DISPLAY FILE - DF 502 - B4 size
20 Clear-view pockets. Extra large pockets hold upto six sheet in each.

- Blue
- Black
- Grey



ROLLOVER SHOW FILE - DF 402 - A4 size
A4 Landscape size. Extended Flap for closure. 20 Clear-view side loading pockets.

- Black



DISPLAY FILE with case / DF 204 - A4 size
80 Clear-view pockets. Side loading. Papers never fall-out of the file. Extra large pockets hold upto six sheet in each.

- Blue
- Black
- Grey

Code	Description	Size
DF 200	Display File - 10 Pockets (Top loading)	A4
DF 201	Display File - 20 Pockets (Top loading)	A4
DF 202	Display File - 40 Pockets (Top loading)	A4
DF 203	Display File - 60 Pockets (Top loading)	A4
DF 204	Display File - 80 Pockets (in a case) (Top loading)	A4
DF 210	Display File - 10 Pockets (Top loading)	F/C
DF 211	Display File - 20 Pockets (Top loading)	F/C
DF 212	Display File - 40 Pockets (Top loading)	F/C

Code	Description	Size
DF 213	Display File - 60 Pockets (Top loading)	F/C
DF 230	Display File - 30 Pockets (Top loading)	A4
DF 301	Secure Display File - 20 Pockets (Side loading)	A4
DF 302	Display File - 20 Pockets (Side loading)	A4
ZB 011	Display File - 20 Pockets (Zipper Closure)	F/C
ZB 012	Display File - 40 Pockets (Zipper Closure)	F/C
DF 501	Display File - 20 Pockets (Top loading)	A3
DF 502	Display File - 20 Pockets (Top loading)	B/4
DF 402	Rollover Show File - Landscape (Side loading)	A4

Document Bags / Envelopes

EXPANDABLE

-  Transparent Pink
-  Transparent Green
-  Transparent Blue
-  Transparent White



Flap cover & Button closure

DOCUMENT ENVELOPE - CH 107 - A4, FC size
Self expanding construction. Transparent shades. Button closure. Holds upto 250 sheets.

-  Blue
-  Orange
-  Pink

Pocket on back side

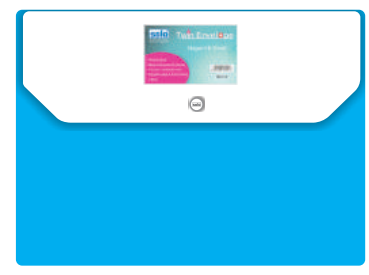





MY CLEAR BAG - MC 212 - FC size
Twin (back side) pocket. Double color. Button closure. Thick material in electrifying shades.

-  Transparent White



DOCUMENT ENVELOPE - CH 104 - A4 size
Specially designed with a string to lock and unlock. Holds upto 250 sheets.

EXPANDABLE

-  Transparent Yellow
-  Transparent Pink
-  Transparent Green
-  Transparent Blue
-  Transparent White



MY CLEAR BAG - MC 112 - FC size
Button closure. 10x12 dot matrix printouts can fit in easily. Elegant with superb quality. Holds upto 150 sheets in legal size.

Zipper



Zipper Document Bag - MC 106, MC116, CH 308 - A5, A4, FC size
Transparent sheet. High Quality. Thick & Durable. Zipper closure with strong ultrasonic bonding for longevity.

-  Transparent White

EXPANDABLE

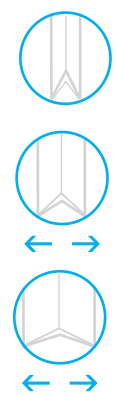

-  Transparent White

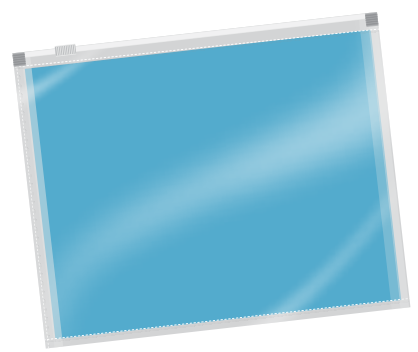

DOCUMENT BAG - ZIPPER CLOSURE - MC 105, MC 115 - A4, FC size
Expandable construction with zipper closure. For documents, student, offices & general purpose use.

Code	Description	Size
CH 104	Document Envelope (String) (Expanding)	A4
CH 107	Document Envelope (Button) (Expanding)	A4
CH 117	Document Envelope (Button) (Expanding)	F/C
CH 108	Cheque Envelope (Button) (Expanding)	Chq.
CH 109	Document Bag (Velcro)	A4
CH 118	Document Envelope (Button) (Expanding)	F/C
CH 208	Standard Cheque Envelope (Button)	Chq.
MC 102	My Clear Bag (Button Closure)	A4

Code	Description	Size
MC 112	My Clear Bag (Button Closure)	F/C
MC 012	My Clear Bag (Button Closure) Opaque	F/C
MC 113	My Clear Bag (Button Closure)	A3
MC 105	Document Bag (Zipper Closure)(Expanding)	A4
MC 115	Document Bag (Zipper Closure)(Expanding)	F/C
MC 212	My Clear Bag (Twin Pocket - Double Color)	F/C
MC 106	Zipper Document Bag	A4
MC 116	Zipper Document Bag	F/C
CH 308	Zipper Document Bag	A5

Clear Holders

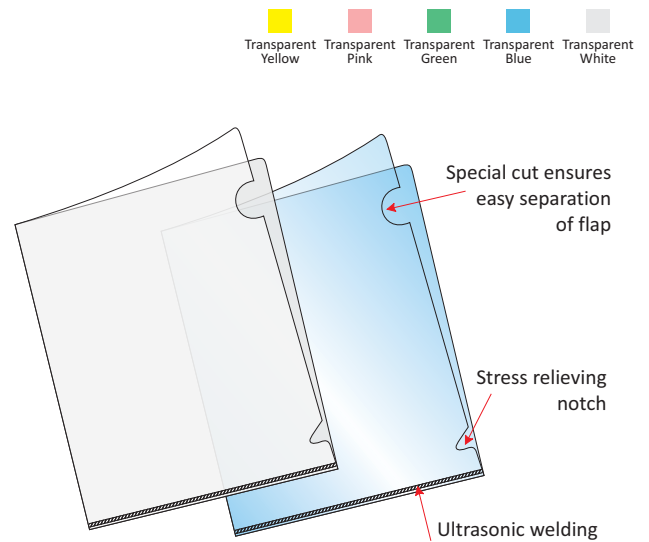
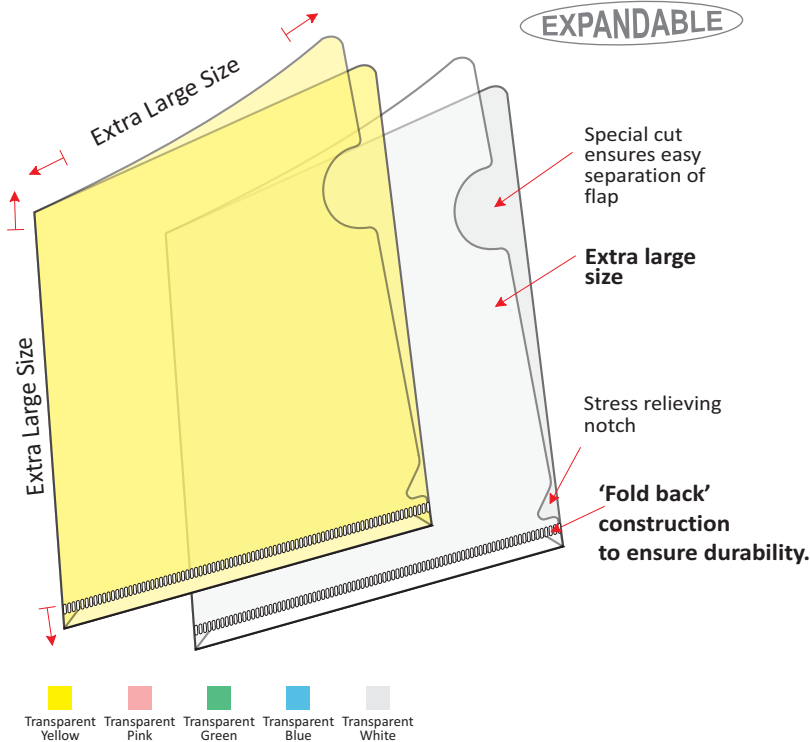

FOLDERS™
SIMPLE | NON STICKY | PROTECTS DOCUMENTS

CLEAR HOLDER - CH 101, CH 111 / A4,FC size

These Clear Holders are constructed to accommodate more double papers than any other ordinary folders that are available in the market. Their special cut ensures easy separation of flap. Ultrasonic welding with "Fold back" construction of bottom edge gives longevity and ensures durable and non-tearing edges. Holds up to 30 sheets.

CLEAR HOLDER - LF 101, LF 111 / A4,FC size

Transparent sheets.
Thumb-cut.
Ultrasonic sealing.
General purpose folders for daily use.



New **solo** Anti-fall secure clear holder.

EXPANDABLE

Extra large size to prevent your paper edges from getting spoilt.



Keep your documents safer

Stress relieving notch

'Fold back' construction to ensure durability.

Folded bottom to accommodate more papers.

SECURE CLEAR HOLDER - SH 101 / A4 size

New solo **Anti-fall** secure clear holder.
Transparent sheets.
'Fold back' construction to ensure durability.
Thumb-cut.
Holds up to 30 sheets.

Transparent White

Loose Sheet Pockets & 'file-in' Bags

Non Sticky



Transparent Clear

SHEET PROTECTOR - SP 101, 102, 103, 104, 111 - A4, FC size
Clear transparent document pockets. Easy filing for ring binders. Embossed surface for easy slip-in/out of paper. 11 punch holes.



Transparent Yellow
Transparent Green
Transparent Blue
Transparent White

Visiting card pockets

Velcro Flap Closure

DOCUMENT FILE-IN BAG - CH 201 - Side Loading - A4 size
Pre-punched holes to fit in any file. Transparent sheet. Velcro flap closure. Heavy duty construction. Holds upto 30 sheets. Life time use.



Transparent Clear

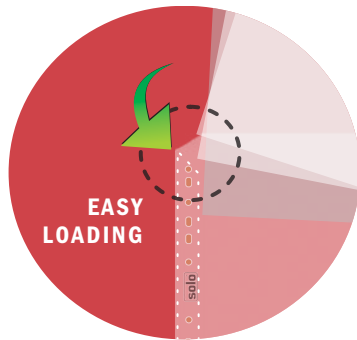

SHEET PROTECTOR - TOPNOTCH POCKETS SP 201 - A4 size
Special notch for wide passage way for simple & swift paper loading. Heavy duty material. Clear view pocket. Holds upto 30 sheets in each.

EXPANDABLE



Transparent Blue

DOCUMENT FILE-IN BAG - CH 202 - Top Loading - A4 size
Transparent front and back cover. Apt for keeping reports, documents, certificates. Velcro lock for safety purposes. Available in A4 size. Holds upto 90 - 100 sheets.

Easy Top Closure flap

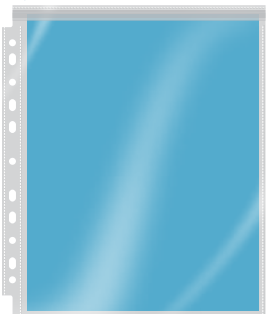

Transparent Clear



SHEET PROTECTOR - SAFEGUARD - SP 401 - A4 size
Clear transparent document pockets. Load up to 20 pages of A4 size in each. 11 punch holes. Heavy duty construction. Tuck-over flap to keep your documents secure from all four sides.

Transparent Blue

EXPANDABLE



EXPANDING BAG WITH 11 HOLES - CH 203 Side Loading - A4 size
Transparent front and back cover. Apt for keeping reports, documents, certificates. Button closure. Available in A4 size. Holds upto 90 - 100 sheets.

Code	Description	Size
SP 101	Sheet Protector (Regular)	A4
SP 102	Sheet Protector (Heavy duty - SILVER)	A4
SP 103	Sheet Protector (Heavy duty - GOLD) ²	A4
SP 104	Sheet Protector (Heavy duty - DIAMOND) ³	A4
SP 201	Sheet Protector (Easy loading, Extra wide, Heavy duty)	A4
SP 401	Sheet Protector (Safeguards) (Four sides closure)	A4
SP 501	Sheet Protector (Easyload) (Four sides closure)	A4

Code	Description	Size
SP 111	11- Hole Sheet Protector	F/C
SP 113	11- Hole Sheet Protector	A3
File-IN BAG		
CH 201	Document File-in Bag-Side loading velcro closure	A4
CH 202	Document File-in Bag-Top loading velcro closure (Expanding)	A4
CH 203	Expanding Bag With 11 Holes-Side loading (Expanding)	A4



Plastic Reinforced Tabs for all-time durability.



Reinforced Tear-proof 11 Punch holes for repeated use & fits into 2, 3 or 4-Ring Binders



Both side printed Tabs allow easier identification.



SP 505

SP 510

SP 520

SEPARATORZ™ - SP 505.....SP 520 - A4 size

Set of 5/10/12/20 Separatorz. Pre-numbered multicolor divider tabs. Reinforced edge with universal 11 hole punch. Color match index sheet with pointers converging to tab. Use any OHP marker to write on tabs.



SEPARATORZ™ - SP 310.....SP 312 A4 size

Set of 10/ 12 Separatorz in plastic. Multicolor. Free Table of Contents.

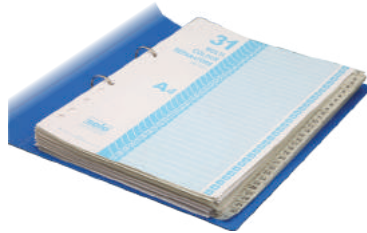

SEPARATORZ™ - SP 220.....SP 231 A4 size

Set of 20/31 Separatorz. Uni color tabs. Reinforced edge with universal 11 hole punch. Use any OHP marker to write on tabs.

- Transparent Yellow
- Transparent Red
- Transparent Green
- Transparent Blue
- Transparent Orange

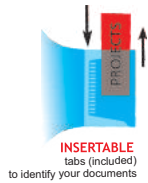

DOCUMENT POCKETS DIVIDERS WITH INSERTABLE TABS - DD105//DD110 - A4

Set of 5 & 10 tabs. Full A4 size folder with index tabs. Insertable tab tickets of paper board to write subject using any pen. Holds upto 10 sheets in each pockets.



SEPARATORZ™ (DIVIDER)

SP 105.....SP 110

- Transparent Yellow
- Transparent Red
- Transparent Green
- Transparent Blue
- Transparent Orange

Set of 5 & 10 tabs. Multicolor. Free Index tickets. Tab tickets always safe & can be changed.



FLIPPER INDEX TABS - IT001

Thick & rigid permanent tabs. Helps you open directly to the desired section. Write subject by Pen / Pencil / Marker on both side of the tab. Stick to plastic & paper alike. Classify your reading reference to flip-open the right chapter/page directly.

Code	Description	Size
PLASTIC / INSERTABLE TABS/MULTI COLOR		
SP 105	Separatorz / Divider (Set of 5)	A4
SP 110	Separatorz / Divider (Set of 10)	A4
PLASTIC / UNI / MULTI COLOR (WITH INDEX)		
SP 310	Separatorz (Set of 10) – multi-colour	A4
SP 312	Separatorz (Set of 12) – multi-colour	A4
SP 220	Separatorz / Divider (Set of 20) – uni-colour	A4
SP 231	Separatorz / Divider (Set of 31) – uni-colour	A4

Code	Description	Size
PAPER (with index) / REINFORCED PUNCH HOLES / NUMBERED & PRINTED TAB / MULTI COLOR		
SP 505	Separatorz (Set of 5)	A4
SP 510	Separatorz (Set of 10)	A4
SP 512	Separatorz (Set of 12)	A4
SP 520	Separatorz (Set of 20) - A to Z	A4
DD 110	10 document pockets dividers with insertable tabs (Set of 10)	A4

Expansion Cases & Document Cases

EXPANDING CHEQUE CASE EX 701, CHEQUE size - 12 Sections



Blue
Black
Grey

EXPANDING FILE - EX 801, EX 802 A4 size

12 Sections. Elastic closure.
Free Multi-colour tabs.
Fabric sewing on edge.



Metallic Blue
Metallic Grey

QUAD-PRO - 4 SECTION FOLDER - EX 905 - A4 size

4 section expanding pockets. Elastic closure. Holds over 200 sheets. Slip down pockets to easily locate documents.



Blue Black Grey Dual Tone Translucent Blue Wave Grey

EXPANDING FILE - EX 903 - FC size

12 Sections. Available with lock & handle.
Free Multicolor tabs. Fabric sewing on edge.



Wave Blue

DOCUMENT MANAGER - EF 301 - A4 size

6 section + Partition Dual color, dual tone metallic finish. Expanding fabric. Elastic closure. Full bottom & side expanding sections.



Blue
Black
Grey

EXPANDING CASE - EX 904 - FC size

Available with Lock & Handle. 31 Pockets in 12x3 Sections. Free Multicolor tabs.



Blue Black Grey

DOCUMENT CASE - DC 557 - FC size

Specially designed with lock and handle which makes your document safe and secure and ensure easy mobility. Holds more than 350 legal size sheets. Extremely superior quality.



Super Line Blue Super line white Tango Yellow

FLEXI DOCUMENT CASE - DC 555 - FC size

New self expanding document case. Fabric stitched expanding case. Vibrant, transparent & opaque colors. Added net pocket for utility. Lock & handle for convenience.

Code	Description	Size
EX 701	Expanding Cheque Case (Elastic closure) 12 section	Chq.
EX 801	Expanding File (Elastic closure) 12 Section	A4
EX 802	Expanding File (Elastic closure with sewing edge) 12 Section	A4
EX 901	Expanding File (Elastic closure) 12 Section	FC
EX 903	Expanding File (Lock & Handle) 12 Section	FC
EX 904	Expanding Case - 31 Pockets (Lock & Handle)	FC
EX 905	Quad-Pro - 4 section expanding folder	A4
EX 908	Expanding File (Lock & Handle - 12 section)	FC

Code	Description	Size
EF 301	Document Manager (6 section +Partition)	A4
EF 302	Full Bottom Expanding File - 1" case (6+1 pocket)	A4
AC 811	Action Case	A4
AC 812	Action Case	FC
DC 554	Flexi Document Case (with Xtra net pocket)	FC
DC 555	Flexi Document Case (with Xtra net pocket +Lock & Handle)	FC
DC 556	Document Case (Slot closure)	A4
DC 557	Document Case (Lock & Handle)	FC
DC 558	Document Case (Elastic closure)	A4

Conference Files & Personal Portfolio



■ Metallic Blue
■ Metallic Grey
■ Black

PORTFOLIO with pad - EF 886 - A4 size
 6 section expanding pockets. Notepad included. Additional net pockets with zip for CD's pens & cards.



■ Blue ■ Black ■ Grey ■ Green

CONFERENCE COMPANION with pad & pen - CC 101 - A4 size
 Self expanding pockets on inside cover.



■ Peacock Blue ■ Purple

CONFERENCE EXPANDING FILE with pad & pen - EF 884 - A4 size
 6 section expanding pockets. Dual color, dual tone. International looks. Metallic matte finish. Writing pen & pad included. Pockets for CD's & cards.



■ Tango Yellow ■ Tango Green ■ Tango Blue

DOCUMENT BAG with pad - CC 105
 An economy conference folder with a large pocket for A4 sheets & slots for CD. Can be ordered with or without note pad.



■ Magic Square Grey

EXECUTIVE DOCUMENT CASES - DC 107
 Elegant landscape size executive business case. 3 Large sections with zipper pockets that enables you to keep documents, papers, tablet etc. Dual tone metallic finish. Zipper pockets inside & outside.

Secure expanding pocket with velcro lock



■ Wave Blue ■ Wave Grey



MEETING FOLDER - secure expanding pockets - CC 115 - A4 size
 Expanding pocket on left side to keep 25 sheets. With pad & pen.

Code	Description	Size
EF 884	Conference Expanding File - 6 pockets with pad & pen	A4
EF 886	Executive Portfolio - 6 Sections With Pad	A4
EF 829	Magic Square Portfolio - 6 section expanding pockets with pad	A4
CC 105	Document Bag with Pad	A4
CC 108	Secure Folder with Twin Pocket	A4
CC 109	Conference Folder	A4

Code	Description	Size
CC 101	Conference Companion With Pen & Pad	A4
CC 102	Conference Companion Without Pen & Pad	A4
CC 103	Secure Companion With Pen & Pad	A4
CC 104	Secure Companion Without Pen & Pad	A4
CC 115	Meeting Folder with secure expanding pocket	A4
CC 116	Meeting Folder with secure expanding pocket without Pad	A4

DVD / CD Zippers & Business Card Holders



CD WALLET ZIPPER - CD032

Capacity 32 CD's. Zipper closure. Handle. Strong pockets complimented by strong PP cover.



CD WALLET ZIPPER - CD080

80 CD's. Zipper closure. Handle. Extra pocket on cover for Pen Drives & SD cards.



CD POCKET WITH LABEL - CD010

Both side pockets (4 CD's). Labels to make note of contents in CD. Suitable for attaching to Ring Binders. Lifetime durability.



BUSINESS CARD HOLDER - BC802

240 card holder with embossed ultrasonic welded pocket, for lifetime durability. Non-stick pockets.



BUSINESS CARD HOLDER - BC805

240 card holder in slipcase/jacket with embossed ultrasonic welted pocket. Anti-static agent for zero sticking of business cards. Lifetime durability.

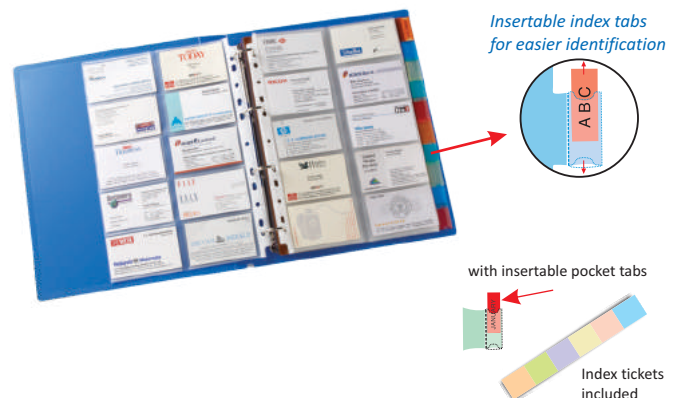

Insertable index tabs for easier identification

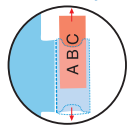

with insertable pocket tabs

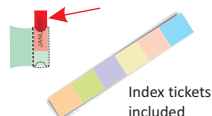

REFILLABLE BUSINESS CARD ORGANIZER - BC807 - A4 size

A4 sized 25x20 card pockets with ultrasonic welted pockets. Comes with 10 dividers with insertable pockets on index tabs. Free index tickets included. Organise cards by subjects correlating to your business routines.

Code	Description	Size
CD032	Computer CD Wallet -PP (32 CDs)	32 CD
CD080	Computer CD Wallet Zipper (80 CDs)	80 CD
CD010	Computer CD Wallet Pocket with Label (for Ring Binders)	4 CD

Code	Description	Size
BC801	Business Card Holder	120 Cards
BC808	Business Card Holder - 1x480 Cards (in a Case)	480 cards
BC810	Name Card Pocket (refillable in all files) (10 section each)	20 cards

Executive Notebooks



NOTEBOOK - NA 552, NB 552 - A5,B5 size
Dual colour printed polycover in A5 and B5 sizes. Double wire bound. Extra smooth writing paper. 100 pages.



NOTEBOOK - NA 551, NB 551 - A5,B5 size
Extra smooth writing paper. Line ruled. It is lightweight, easy to carry and offers great convenience to your life. 100 pages.

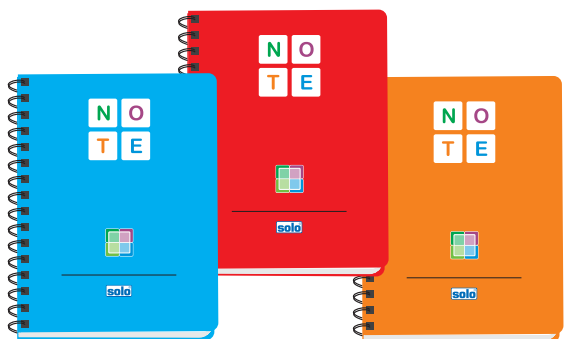

NOTEBOOK - NA 578, NB 578 - A5,B5 size
Strong and durable polycover in A5 and B5 sizes with extra smooth writing paper. 140 pages.



PREMIUM NOTES PAD - NA 500 - A5 size (Vertical)
Extra smooth writing paper. Line ruled. It is lightweight, easy to carry and offers great convenience to your life. 100 pages.



NOTEBOOK - NA 404 - 28*21.5cm size
Available in 160 square pages. Best option for students to take down the notes on extra smooth perforated paper notebooks with detachable scale on cover for their convenience.



NOTEBOOK - NB 506 - B5 size
Available in 160 square pages. Best option for students to take down the notes on extra smooth perforated paper notebooks with detachable scale on cover for their convenience.

Code	Description	Size
NA 403	Premium Notebook (160 pages)	28X21.5cm
NA 404	Premium Notebook (160 pages, Square)	28X21.5cm
NA 501	Premium Notebook (160 pages)	A5
NB 505	Premium Notebook (160 pages)	B5

Code	Description	Size
NB 578	Notebook (140 Pages)	B5
NA 578	Notebook (140 Pages)	A5
NB 552	Notebook (100 pages)	B5
NA 552	Notebook (100 pages)	A5

5-Subjects Notebooks



5-SUBJECTS NOTEBOOK - NA 553 - A5 size
Strong poly-cover. Re-attachable dividers to allocate desired number of pages for each subject. Index page. SmoothSplit™ Perforation. 300 pages.



with Insertable Index tickets



5-SUBJECTS NOTEBOOK - NA 555, NB 555 - A5, B5 size
Strong poly-cover. 5 re-attachable Poly Dividers. Insertable pockets on index tabs. Index page. SmoothSplit™ Perforation. Pocket on inside cover. 300 pages.



5-SUBJECTS NOTEBOOK - NA 554, NB554 - A5, B5 size
Strong poly-cover. Re-attachable dividers to allocate desired number of pages for each subject. Index page. SmoothSplit™ Perforation. 300 pages.

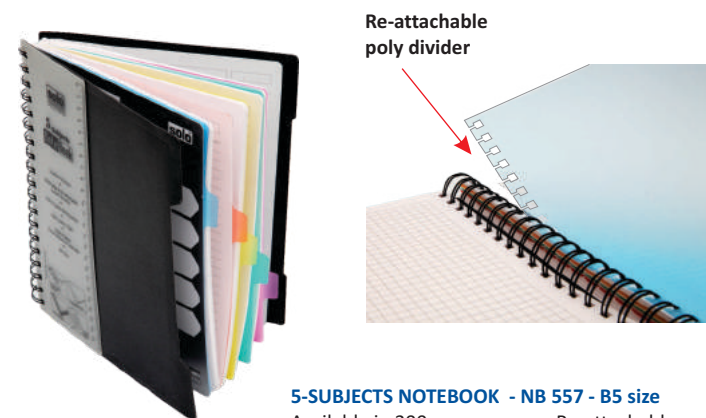

Re-attachable poly divider

5-SUBJECTS NOTEBOOK - NB 557 - B5 size
Available in 300 square pages. Re-attachable poly dividers. Available with perforation.



5-SUBJECTS NOTEBOOK - NA 457 - 28*21.5CM size
Available in 300 square pages. Smooth split perforation. Detachable scale on cover. Double wire O ring binding. Line Ruled. Monthly planner. Multi index cut. 1 storage pocket.



3-SUBJECTS NOTEBOOK - NA 633 - A6 size
Strong poly-cover. 3 re-attachable Poly Dividers. Index page. 240 pages.



Code	Description	Size
NA 555	5-Subjects Notebook (300 pages, Insertable Tabs dividers)	A5
NB 555	5-Subjects Notebook (300 pages, Insertable Tabs dividers)	B5
NA 556	5-Subjects Notebook (300 pages, Dividers)	A5
NB 556	5-Subjects Notebook (300 pages, Dividers)	B5

Code	Description	Size
NA 553	5-Subjects Notebook (300 pages, Dividers)	A5
NA 554	5-Subjects Notebook (300 pages, Dividers)	A5
NB 554	5-Subjects Notebook (300 pages, Dividers)	B5
NB 557	5-Subjects Notebook (300 pages, Square, Dividers)	B5
NA 633	3-Subjects Notebook (240 pages)	A6

Desktop Accessories

Blue Black Grey



**PAPER & FILE TRAY
TR 112, TR 113
XL size**
Set of 2/3 trays.
Interlocking raisers.
Apt for gifting purposes.

Black

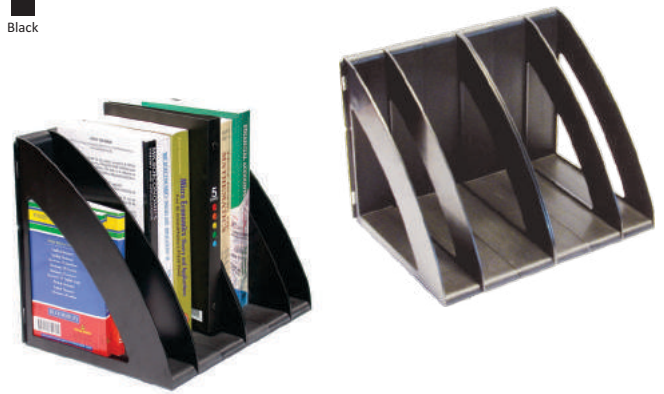

BOOK RACK - FS 106
Set of 6 pieces. Made from durable material.
Dual purpose rack for keeping
Easy to assemble.

Blue Black Grey



'DELUXE' PAPER & FILE TRAY - TR 312 - XL size
Increase or Decrease the number of trays according to your need.
Doubles up as a paper stand behind standard dot matrix printers.



FILE & MAGAZINE RACK - FS 201 - XL size
Organize files & magazines in offices & home.
Spine Label to write subjects for bulk storage.
Extra large size to keep heavy books.

Blue Black Grey



FILE & BOOK RACK - FS 301 - XL size
Spine Label to write subjects for bulk storage.
Extra wide to accommodate large files.
Superlative quality.

Blue Black Grey

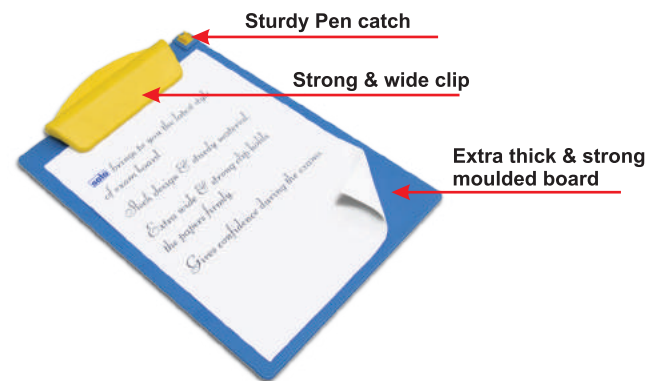

STUDENT EXAM PAD - SB 001 - A4 size
Extra thick and strong moulded board.
Strong and wide clip to hold your paper firmly. Sturdy pen catch.

Blue

Code	Description	Size
TR 112	Paper & File Tray (2 Pcs. Set)	XL
TR 113	Paper & File Tray (3 Pcs. Set)	XL
TR 312	'Deluxe' Paper & File Tray (2 pcs. Set)	XL
FS 106	Book Rack (6 pieces in a set)	Table top

Code	Description	Size
FS 201	File & Magazine Rack	XL
FS 301	File & Book Rack	XL
SB 001	Student Exam Pad	A4

Desktop Accessories



Blue Black Grey

DESK ORGANIZER - DL 102

Can keep all desk-top accessories like, pen, pencil, glue stick, scale, calculator, scissors, etc.

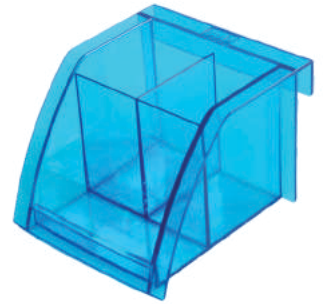

Turquoise Green Transparent White Transparent Brown Blue

MULTI-PEN STATION - DS 201

2 sections to keep pen, scissors, glue-stick, scale etc. Transparent and elegant design. Keeps your desk neat and suave.



Blue Turquoise Green Transparent White Transparent Brown

MULTI-PEN HOLDER - DS 101

Can keep all desk-top accessories, like, pen, pencil, glue-stick, scale, calculator, scissors, etc.



Turquoise Green Transparent Brown Smoke Blue

OPERA DESK ORGANIZER - DL 202

5 sections to keep pen, scissors, glue-stick, scale etc. Transparent and elegant design.



Magic Square Blue Magic Square Black Magic Square Grey

PAD BOARD WITH ENVELOPE POCKET - PB 111 - FC size

Strong pad board with punchless clip on top and self expansion pocket with Velcro closure to securely hold over 25 sheets.



Green Black Blue White



ALL-ROUNDER DESK ORGANISER - DL302

8 sections to keep pen, pads, remote, scissors, glue sticks, scale etc. almost everything on a office desk. Keeps your desk neat and suave. Smallest compartment accessible by finger tips to tweeze & pick small objects conveniently.

Code	Description	Size
DL 102	Desk Organizer (Opaque)	-
DL 202	Opera Desk Organizer (Transparent)	-
DS 101	Multi-pen Holder (Transparent)	-

Code	Description	Size
DS 201	Pen Station (Transparent)	-
PB 111	Pad Board with envelope pockets	FC
DL302	All Rounder Desk Organiser	-

Desktop Accessories

RotoClip™ Archiving & Filing Clip

For filing over 1000 sheets or loose paper

RotoClip is a simple and effective instrument to organize loose sheets. It is a standalone usage clip for students to keep their class notes bundled. Just need to punch the loose papers with insert prongs through punched holes. Rotate screw top to fasten papers and cut-off extra prong length by scissors.

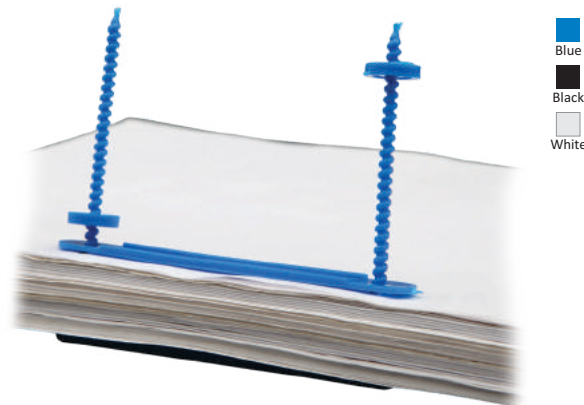

Blue
Black
White



Item code:
RC 123



LED MAGNIFIER

White

- Engineers may use it to study any small object minutely.
- Helpful for doctors to see inside the mouth and check throat.
- Useful in workshop for repair & maintenance of machinery even in dim light.
- Best use for students in dim light conditions.
- Useful for antique collectors & jewelers to deeply study the details of their collection.



LM 777

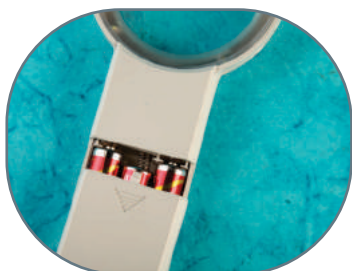

Art Portfolio Bags

DESIGNER PORTFOLIO BAGS - AR1A1 | AR1A2 | AR1A3

- Useful for students, architects, designers & more.
- A1 size bag with long flexible handles to hang on shoulders.
- Strong poly zipper & water resistant fabric used in construction.
- Double zipper pouch inside for keeping pens, colors, eraser, marker, pins etc.
- Holds upto 150 sheets.



Black

BUSINESS CARD / LABEL SELF ADHESIVE POCKETS

SIDE LOADING (PKT01), TOP LOADING (PKT02)

- Easy to use.
- Sticks strongly to any surface.
- Highly transparent.
- Stick to plastic & paper alike.
- Special slot to push-out & change old label/card.
- Use freely on paperboard, wood, steel, glass etc

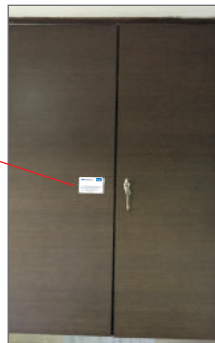

SIDE LOADING - PKT01



Transparent
Clear

Laptop Accessories



FOLDABLE



FIRM AND SOLID



FAST HEAT
DISSIPATION



ANTI SLIP

Size Compatibility

13.1" to 15.6"

Brand Compatibility

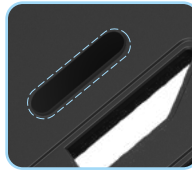

Anti-Skid Pads



Handle



Anti-Skid Strip



LS101

MAXICOOL LAPTOP STAND

One Stand-Multiple Fans-All Comfort

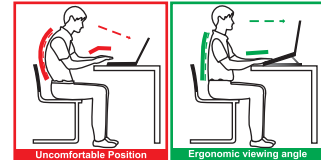

LS104

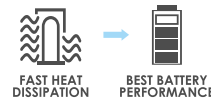

FAST HEAT
DISSIPATION

BEST BATTERY
PERFORMANCE



Laptop Accessories

For Laptop Keyboards

Made of super soft, synthetic, transparent silicone rubber that protects your keyboard from dust & from accidental spillage of liquids. Keeps your laptop keyboard new for ever.



KS 101

Transparent, heat resistant and easily washable keyboard protector skin helps you to protect your laptop keyboard from damage even if hot tea or any liquid spills on it.



KS 102 - Xtra Large

Anti bacterial flexible skin which does not fall off even if laptop is turned upside down.



No special adhesive is required to stick to the keyboard as the skin sticks with its natural static and comes in extra large size.

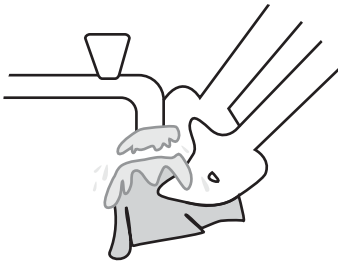

Easily removable and washable skin. Just need to rinse it with water. Allow it to dry and its ready to use again. It increases the life of the keyboard by giving lifetime use.

Transparent Clear

Code	Description	Size
KEYBOARD SKIN		
KS 101	Keyboard Protector Skin (140mm x 318mm)	-
KS 102	Keyboard Protector Skin (143mm x 368mm)	-



iCLENE™

iCLENE is a multi functional product which not only cleans laptop displays effectively but also is the best means to keep all the glass items always SPARKLING...be it a laptop, desktop, digicam, LCD, spectacles, other glass items etc. This non-streak cleaning aqua comes in pump-spray applicator in union with a washable ultra-fine micro-fiber cloth that easily removes dust, lint, oil, grease and fingerprints from every screen and glass surface of office and household equipments.



Lens & Glass iClene Cleaning Kit - IC106

A special soft brush to keep all hard to reach areas of a laptop /desktop dust free. Accompanied with washable wonder cloth made of micro filament fibre which removes Dust, Dirt, Oil, grease finger prints and Lint completely. International quality standards maintained

Multi-function Bags with Two Pockets

- Useful for students, designers & more
- Easy to use
- Durable
- Water resistant
- Additional see through net pocket



MFA42, MFA52, MFA62



STUDENT PENCIL BAG

STUDENT PENCIL BAG - PB 104

- Special use for saving kit, architecture kit, student kit, carpenter kit etc.
- Pencil Bag becomes a pleasure to use if it also looks good, besides being user-friendly
- Bright Colours
- Transparent student pencil bag

PENCIL BOX - PB 103

- Useful for students, architects, designers & more
- Pencil Box becomes a pleasure to use if it also looks good, besides being user-friendly
- Bright Colours
- Plastic Pencil Box



PB 103

PB 104

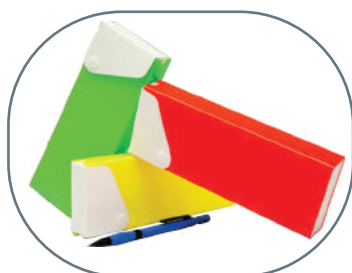

My Zipper Bag

- Nylon braid reinforced polymer sheet to give years of durable use.
- Nylon braid stitching hold heavy contents.
- Transparent bags with smooth zip closures.
- Multipurpose use at home, office or school.
- Pack of 5 in five vibrant zipper colors.



ITEM CODE:
MFFC1 (FC), MFA41 (A4), MFA51 (A5), MFA61 (A6)



Clutch Pencils

Blue Black Green Red



First Time in India
Tip with SAA technology
(Shock Absorber Action)

Ergomatic™
PRECISION PENCIL WITH
SHOCK ABSORBER ACTION (SAA)



Metal body | Highly precise | Suitable for Students, Engineers, Architects, Designers, Executives etc. | Built-in Twist eraser | Refill lead reservoir

STUDY 0.5 | EXECUTIVE 0.7
PL405 | PL407

Jetmatic™ 0.5/0.7
Automatic lead streaming pencil



PL205 | PL207
Blue Yellow Green Red

PL305

Smart fluorescent body | Automatic lead streaming | Suitable for Executives, Students, Engineers, Architects, Designers etc. | Twist roto eraser

Aktion 2.0
Clutch Pencil



PLA02
Blue White Yellow

Vibrant colors | Smart anti-slip comfortable grip | 2 mm lead, Writes like wood pencils | Eco-friendly & wood free | Cap cum sharpener needs just 3 seconds to sharpen tip.

0% LOSS Edge contact technology **Ever Sharp**
No Breakage



Clutch Pencils & Leads



KineticaTM

0.5 | 0.7

PL105 | PL107

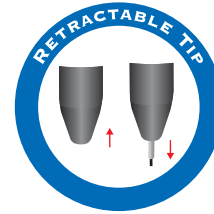

Vibrant color | Light weight | Retractable tip | Twist eraser
| Same width as normal wood pencils | Soft rubber grip

Dazzler 0.7
Clutch Pencils



PL707
Blue Black Green Red Purple

Gudluk 0.5 Duo
Clutch Pencils with Kinetica Leads



PL605
Blue Pink Green Red

KineticaTM
PENCIL LEAD



1TIKTM
PENCIL LEAD



0.5 H 0.5 HB 0.5 2B 0.7 HB 0.7 2B

You don't have to get up in the middle of your class to sharpen your pencil.
Just click and keep writing. Continue to take your important notes or doodle as much as you want.
Dazzler pencils come with extra smooth 'RETRACTABLE TIP' and prevents lead breakage.
Convenient for long writing with fewer clicks.

Visual Communication Accessories

MAGNETIC Data Holder

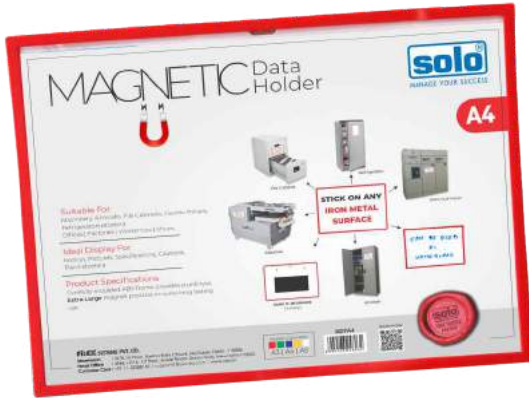
- Suitable For Machinery, Almirahs, File Cabinets, Electric Panels, Refrigerators etcetera
Offices | Factories | Workshops | Shops
- Ideal Display For Notices, Pictures, Specifications, Cautions, Plans etcetera
- Product Specifications Carefully moulded ABS frame provides sturdiness Extra Large magnet provides ensures long lasting use



MDF A3 - A3, MDF A4 - A4, MDF A5 - A5

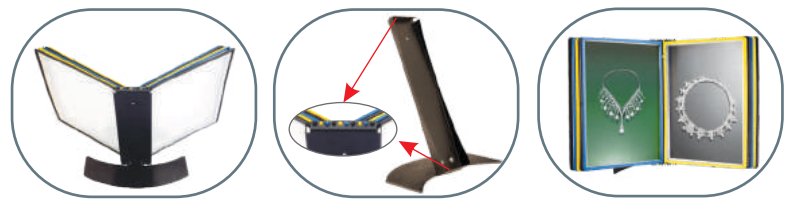

Display Folders

with Heavy Duty Desk Stand ► For desk tops

DS 105 - Desk stand with 5 folders
DS 110 - Desk stand (for 10 folders)



DISPLAY FRAME WITH
RE-ATTACHABLE HANGING HOOK

Code: DF005 | A4
Use for the ready display of Notices, Pictures, Specifications, cautions, etc in office, factories & shops.

Visual Communication Accessories

DISPLAY FOLDERS WITH WALL UNIT

WDF05 - 5N | WDF05 -10N (A4 size)

Stainless steel wall mount unit with powder coating for long life.
Display folders with easy loading pockets with special lock mechanism to avoid paper from falling.



MAGNETIC STUDS

For ready display of Notices, Pictures, Specifications, cautions, etc in office, factories & shops.

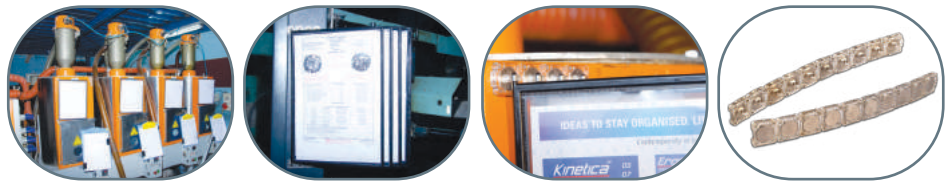

MS 110 - Magnetic studs (Set of 10 pcs)

FM 510 - Set of 5 folders with 10 pcs magnetic studs

Highlighter

PAPER | COPY | FAX

High quality Korean ink.
Ultra soft highlighting.
Large ink reservoir for extra long performance.
Safe on coloured inkjet printing. Does not smudge.
Copy proof. Almost zero shadow when highlighted documents are photo copied.

NEW
& **IMPROVED** **EXTRA LONG SHELF LIFE**



Refillable Whiteboard Marker

**NEW
& IMPROVED**

writes
3X
times longer



Blue Black Green Red

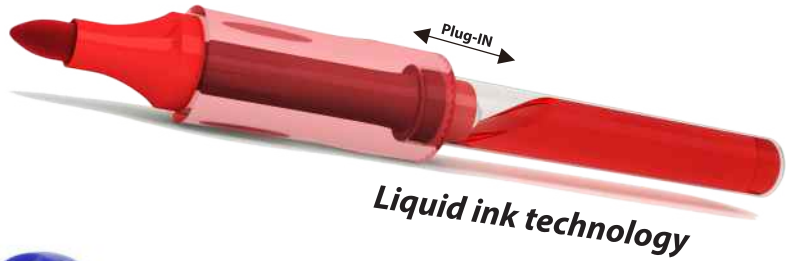

Liquid ink technology

REFILLABLE WHITEBOARD MARKER

WBM01

Liquid Ink Technology: Writing efficiency redefined with 3 Times longer performance than any other marker

Cartridge System: Just 'plug-in' a new cartridge. No more hassle of drip filling the markers.

Same Performance With Each New Cartridge: Korean Ink & Japanese Tip help makes sure there is no fall in writing experience.

Visible From A Distance: Specially formulated ink is visible from distance so no one misses out

Inclined Writing Made Possible: The marker allows you to write with at inclined angels like never before.



WHITE BOARD MARKER INK REFILL

WBR01 - BLACK
WBR02 - BLUE
WBR03 - GREEN
WBR04 - RED

REFILLABLE PERMANENT MARKER

PM001

Oil-based, quick dry and strong adherence ink.

Can write on most surface.

Low odour ink, recap tighten after use.

Xylene and toluene free.

Water proof.

Blue Black Green Red



USABLE ON MOST SURFACES



CERAMIC

GLASS



METAL

LEATHER

PLASTIC, WOOD, PAPER, JUTE, ETC.



PERMANENT MARKER INK

IB001

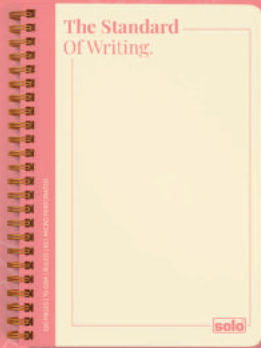

Kraft Notebook



Eco Friendly Notebook



Velvet Finish Notebook

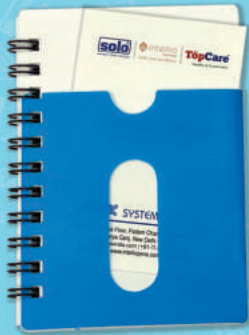

Pocket Notebook



Daily Planner

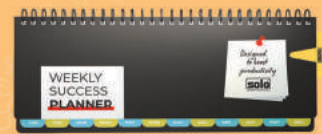

Weekly Planner



Sketch Book



Smartphone & Tablet Stand



Highlighter

New Products

Files / Folders



GRIPPER CLIP FILE

Code: PF006 | A4
Modernized cardboard file with one touch clip.



JUNIOR LEVER ARCH FILE

Code: LA501 | A4
Front side PP coated & backside high quality printed paper. 50 mm (2") clip mechanism.



SPRING ARC FILE

Code: SG803 | A4
Wire prongs on left to hold springs at perfect angle to shuffle & store documents.



DAILY UTILITY FILE

Code: DU101 | A4
Strong ABS polymer clip with gripper mechanism. Holds upto 180 sheets.

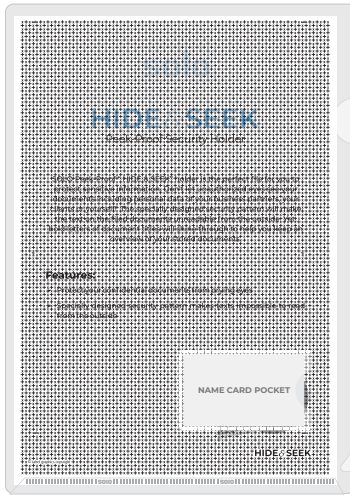

HIDE & SEEK PEEK-PROOF SECURITY HOLDER

Code: CH102 | A4
Protect your confidential documents from prying eyes. Specially designed security pattern makes texts impossible to read from the outside.



MY CLEAR BAG

Code: MC312 | FC
Twin pockets.
10*12 dot matrix printouts can fit in easily.



DUAL DOCUMENTS POCKETS

Code: CH402 | A4
Multi utility documents holder.
Holds upto 50 sheets.

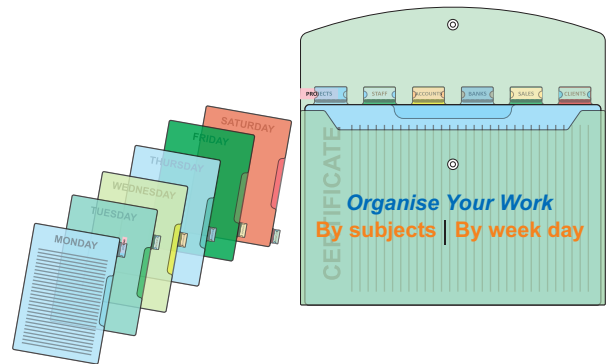

WEEKLY DOCUMENTS ORGANISER

Code: DD206 | A4
Six document pockets in a durable & expandable button folder. Helps to plan a series of meeting with individual reference dockets for each engagement. Each pocket easily holds upto 40 sheets.



FLEXI UTILITY BAG

Code: DC552 | A5
With extra net pocket.
Fabric stitched expanding case.
Button closure.



3 SECTION CLEAR HOLDER

Code: CH110 | FC
Multi utility 3 section clear holder.
Holds upto 30 sheets in each section.

3 Section
CLEAR
HOLDER

Files / Folders

NEON



MY CLEAR BAG

Code: MC112N | FC
Button closure.
NEON colors.
10*12 dot matrix printout can fit in easily.

Flip to open

Tuck-in to close

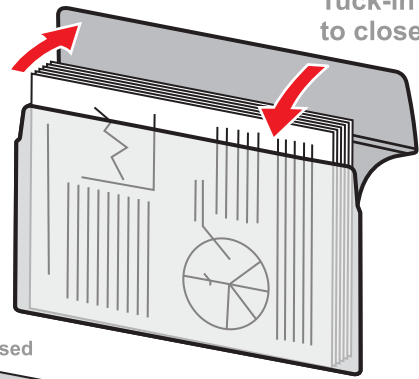

Closed

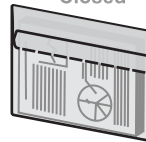

ONE TOUCH HOLDER

Code: SH102 | A4
Quick & easy clear holder that prevents document fall.
25 sheets capacity.

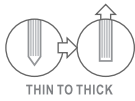

THIN TO THICK

5 POCKET DOCUMENT BAG WITH BUTTON

Code: EX501 (Landscape) | A4
Expanding.
Ultrasonic welding for durability.



BUTTON BAG

Code: MC100 | Cheque
For keeping cheque books, travel tickets, passport, payment receipts, warranty cards, cash memos, etc.

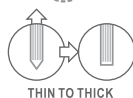
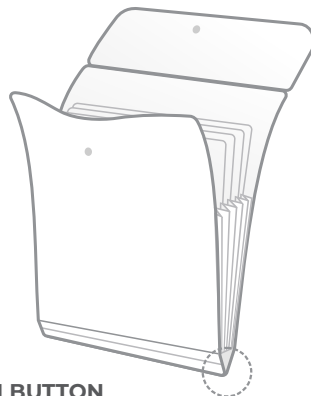

THIN TO THICK

5 POCKET DOCUMENT BAG WITH BUTTON

Code: EX502 | A4
Expanding.
Ultrasonic welding for durability.



BUTTON BAG

Code: MC200 | A5
High quality durable document bag in A5 size for landscape use.
Transparent button bag.

Zipper Bag & Pouch



Expandable
Large capacity



MY ZIPPER BAG

Code: MC105 | A4
Specially designed hook slider for easy & convenient usage.
Transparent bags.



UTILITY HAND BAG

Code: UBA61 | A6
Metal chain for a longer and durable use.
Nylon braid stitching hold heavy contents.



CARRY.ALL UTILITIES BAG

Code: EVA41 | A4
EVA material.
Smooth zip closure.
Ideal for holding planner, notebooks, stationery item, passport, mobile phone, etc.



PU HANDBAG

Code: PUFC1-FC | PUA41-A4 | PUA51-A5
Leatherette bags for a premium experience



PENCIL POUCHES

Code: PB106 | A6
Colored silicon coated PVC pouches



HOLD ALL HANDBAG

Code: HBA42 | A4
Water resistant. Carry for MacBook.
Lightweight but Build Strong -comes with a handle for easy portability.

Desktop Accessories



STUDENT EXAM BOARD

Code: SB002 | FC
Extra thick and strong moulded board.
Non commercial scale.



UNBREAKABLE EXAM BOARD

Code: SB004 | FC
Strong & wide electroplated wire clip with hanger.
Transparent see through board.
Extra thick & strong moulded board.
Non commercial scale.
Full size - 355x240mm.

SMARTPHONE & TABLET STAND

Code: MS002
The phone stands perfectly compatible with the latest models of leading Smartphones, tablets, and e-readers, including iPhone, Samsung, OnePlus, Mi, Oppo, Vivo. iPad (including Air & Mini) and Kindle.



AD-UP Series



Double Side Stand



Single Side Stand



AD-UP YOUR

RESTAURANT • HOSPITAL • GYM • RETAIL STORE • CONFERENCE • HOTEL

- GET YOUR MESSAGE UNDERSTOOD LOUD AND CLEAR
- INCREASE YOUR SALES
- MAKE AN IMPACT ON YOUR CUSTOMER

Double Side Stand			Single Side Stand		
A4	A5	A6	A4	A5	A6
ASHA4	ASHA5	ASHA6	LSA41	LSA51	LSA61

Lusso Personalle Series (Leatherette)

MACBOOK | ULTRABOOK | NOTEBOOK
For 13" Variants



LAPTOP SLEEK CASE

Code: LPSC1

Crafted from fine Italian leatherette, the laptop sleek case provides your laptop with great protection and you with significant style.



LAPTOP SLEEVE

Code: LPLS1

Crafted from fine Italian leatherette, the laptop sleeve through its timelessly elegant silhouette showcases finesse and makes a statement on your behalf.



LPNB1



LPNB2



LPNB3

PREMIUM NOTEBOOK

Code: LPNB1 (Soft cover) | LPNB2 (Hard cover) | LPNB3 (Hard cover)

Experience personal luxury with every stroke, touch or eye contact. A notebook for today and tomorrow.



UTILITY BAG

Code: PU 105

Leatherette pouches for a premium experience

Notebooks



Kraft Paper Notebook - NA502

Size: A5 (8.3x5.8") / 210x148 mm
Paper: 120 pages (Ruled)
Cover: 450 gsm beige paper
Inner Packing: 16N
GSM: 70

Inner Pages: Each spiral notebook has 120 ruled pages of 70 gsm each. The paper is smooth and easy to write without ink penetration. Fountain pen friendly, the paper ensures a pleasurable writing experience regardless of the medium

Product Design: Aesthetically pleasing, the notebook features a timeless design with trendy & unique colors. Combined with a thick paper cover, the notebook features specially manufactured wire-o binding which makes sure notebooks opens flat.

Wide Application: This notebook is suitable for classroom, office, etcetera meeting your multiple daily needs. It is lightweight, easy to carry and offers great convenience to your life.

Eco Friendly Kraft Board Notebook - NA503

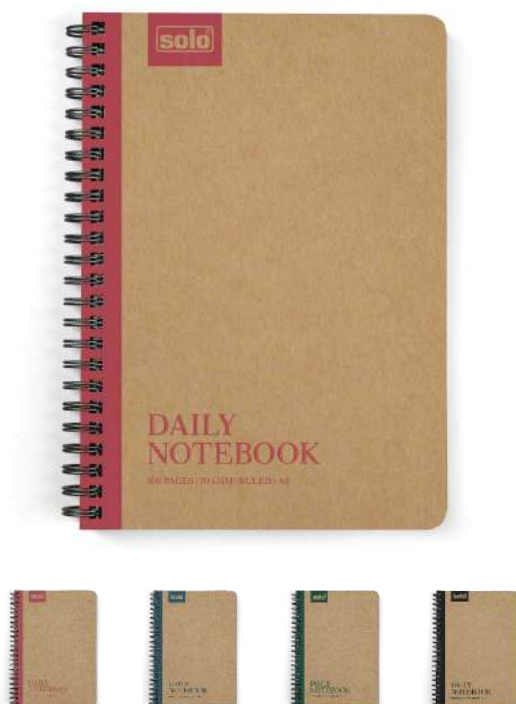

Size: A5 (8.3x5.8") / 210x148 mm
Paper: 160 pages (Ruled)
Cover: 1.2 mm Kraft Board
Inner Packing: 12N
GSM: 70

Inner Pages: Each spiral notebook has 160 ruled pages of 70 gsm each. The paper is smooth and easy to write without ink penetration. Fountain pen friendly, the paper ensures a pleasurable writing experience regardless of the medium

Product Design: Aesthetically pleasing, the notebook features a timeless design with unique colors. Combined with a thick kraft cover, the notebook features specially manufactured wire-o binding which makes sure notebooks opens flat.

Wide Application: This notebook is suitable for classroom, office, etcetera meeting your multiple daily needs. It is lightweight, easy to carry and offers great convenience to your life.

Notebooks



Velvet Finish Notebook - NA504

Paper: 160 pages (**Natural Unruled**)
Size: A5 (8.3x5.8") / 210x148 mm
Cover: 800 micron velvet
Inner Packing: 10N
GSM: 80

Velvet Cover - For the first time in the world - a luxe take on plastic. A soft and opulent finish developed for a rich feeling with every touch.

Inner Pages: Each spiral notebook has 160 unruled pages of 80 gsm natural paper each. The paper is smooth and easy to write without ink penetration. Fountain pen friendly, the paper ensures a pleasurable writing experience regardless of the medium.

Product Design: Aesthetically pleasing, the notebook features a timeless design with luxe velvet cover in rich colors. The notebook features specially manufactured double coil gold wire-o binding which makes sure notebooks lays flat and adding elegant touch.

Wide Application: This notebook is suitable for classroom, office, etcetera meeting your multiple daily needs. It is lightweight, easy to carry and offers great convenience to your life

Pocket Notebook with Visiting Card Holder - NA756



Paper: 100 pages (Ruled)
Size: A7 (72x106 mm)
Inner Packing: 50N
GSM: 70

Wide Application: Easy to carry around. Fits in back pocket, shirt pocket or purse well. It can be used as a travelers notebook, journal, log book, memo pad, diary notebook, etc. With the little mini notepad, you can quickly write down the inspiration that comes across and keep lists and schedules from time to time.

Visiting Card/Paper Pocket: The notebook features a pocket in the front to put visiting cards or any important pieces of paper you might have. The diary also features in a slot inside for the same purpose of holding together receipts/cards or any other valuables.

Planners



WSP01 (300x110mm)



WSPA5 (148x210mm)

Weekly Planner

Back Cover: Cardboard
Paper: 128 pages
GSM: 80

Planner Specs: Undated 53 Week Spread | 128 Pages | 80 GSM White Paper

Week Overview: Goals | Priorities | Backlog | Important Dates | Learnings | Habits | Notes

Daily Overview: Top 3 Tasks | To-Do List

Month Markers: One of its kind re-attachable monthly calendars for use as per your convenience (if needed)

Personal & Professional Development: Set and track your personal and professional goals and record all your achievements

Project Breakdowns: Pages designed to help you navigate and complete large tasks

Layout: Personal Goal Tracker | Professional Success Tracker | 5 Project Breakdown Pages | 10 Note Pages

The planner is tailored to cover the most important aspects of your daily life. The quintessential tool to help you accomplish your professional goals, while helping you track your personal growth and goals.

Daily Planner



TDPB5 (176x245mm)



TDPA5 (100x210mm)

Back Cover: 1.2 mm thick cardboard
Paper: 90 tear off sheets
GSM: 80

Designed To Boost Productivity: No more forgotten deadlines or tasks! Keep track of everything exactly with space for a daily schedule and to do list, as well as an important section. The perfectly daily to do list notepad to adapt to all of your organization needs

THICK PREMIUM PAPER & Card Backing: The mighty to-do list is a work of art for many people, so we made sure each sheet was thick 80gsm non-bleed paper so you could use your favorite pen without any problems. The pad has a solid foundation with a 1.2 mm thick cardboard back to provide the required support.

UNDATED - You can start planning and organizing your daily planner whenever you need, so you will not waste any pages. Easy to tear off pages you have used, start a new fresh day of planning without any baggage.

Reflect: The planner features a section to write your achievement of the day and rate your day on a scale of your choosing. It is important to take out some time to decompress everyday and reflect on the positives and where one can improve the next day.

Mix Media Sketch Book & Memo Sheets

Memo Sheets

- ♦ 78 GSM imported paper
- ♦ 3.7"x3.7" (95x95MM) paper size
- ♦ 300 Sheets
- ♦ Ideal for office, school and home use
- ♦ Suitable notes, messages, checklists and more



MS101

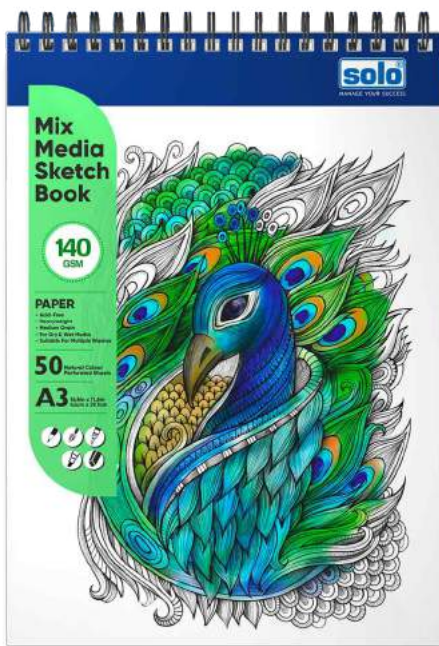

Mix Media Sketch Book

SBA4LD1



SBA3LD1



SBA3PD1



SBA4PD1

A3 | A4
PORTRAIT | LANDSCAPE

Back Cover: Cardboard
Paper: 50 Natural Colour Sheets
GSM: 140

Multi Media Sketchbook – Ideal for Wet and Dry Media like Watercolor, Acrylic, Pastel, Pencil, Charcoal, Art Marker. The speciality drawing paper can be used for sketching, painting, writing, and mixed art creations. The paper is suitable for multiple light washes

ACID-FREE & NON-FADED: Thanks to its 100% acid-free feature, the color will stay as bright and vibrant as it can be over time and will ensure a fresh surface every time you paint. The acid-free white paper also helps reduce smudges, blotches, or transfers.

Personal or Professional-Grade Use – Our sketch book can be used by kids or adults, beginner or pro artists, or DIY hobbyists and crafters. The SOLO Sketchbook satisfies all your needs.

Binding & Cover – Our mixed media sketchbooks feature a metal spiral binding, available in both portrait and landscape orientations, with a smooth flip-open hardcover to make it easier to draw with either hand, and making use of all the space on the page. A 300 GSM back hardcover provides you with all the support you will need for your artwork.

For more details

You can visit our website

www.solo.in

or

Contact us now

FILEX SYSTEMS PVT. LTD.

4546, i-2/16, 1st Floor, Ansari Road, Daryaganj, New Delhi - 110002

support@filexindia.com | +91 9899917532

